

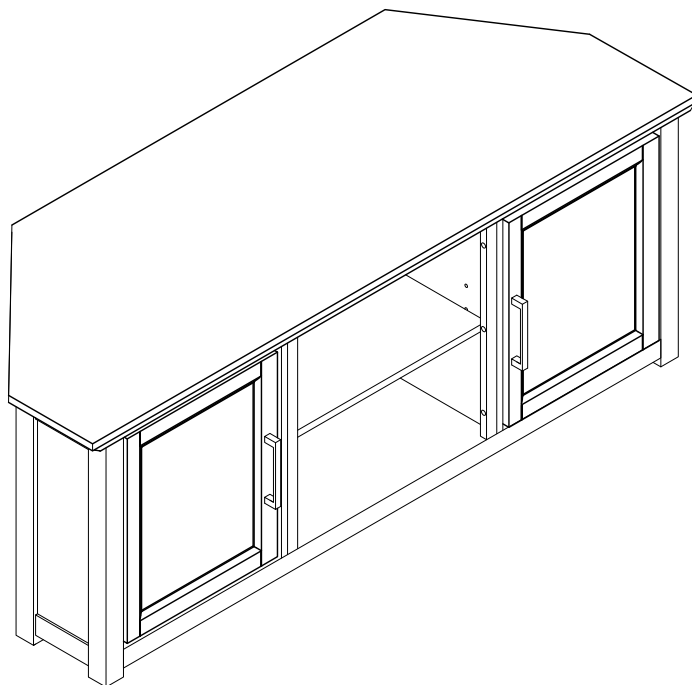

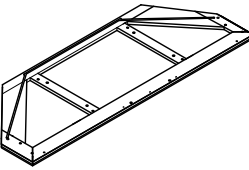

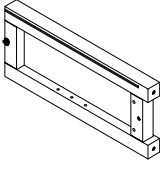

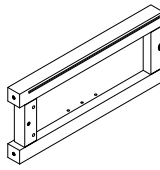

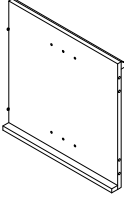
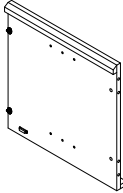
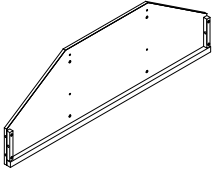
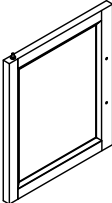
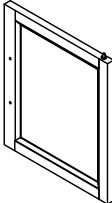
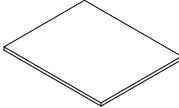

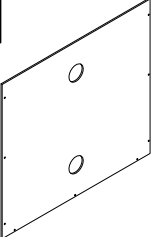
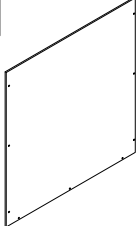
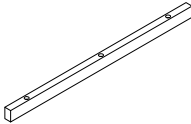
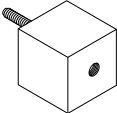
Corner TV Stand
CF101248/CF101258

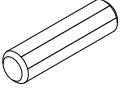
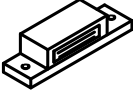
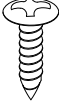
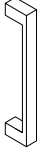
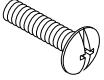

PART LIST

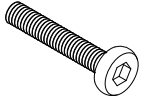
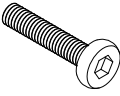
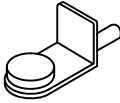
A 	B 	C 	D 	E 
Top Panel 1 PC	Left Panel 1 PC	Right Panel 1 PC	Left Partition Panel 1 PC	Right Partition Panel 1 PC
F 	G 	H 	I 	J 
Bottom Panel 1 PC	Left Door 1 PC	Right Door 1 PC	Middle Adjustable Shelf 1 PC	Adjustable Shelf 2 PCS
K 	L 	M 	N 	
Middle Back Panel 1 PC	Back Panel 2 PCS	Top Rail 1 PC	Support Leg 4 PCS	

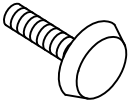
HARDWARE LIST

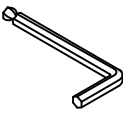
<p>#1</p>  <p>Ø8*30mm</p>	<p>#2</p> 	<p>#3</p>  <p>12mm*Ø3*D6</p>	<p>#4</p> 	<p>#5</p> 
<p>Wood Dowel 18 PCS (Extra 1)</p>	<p>Magnet 2 PCS</p>	<p>Round Head Screw 4 PCS (Extra 1)</p>	<p>Handle 2 PCS</p>	<p>Round Head Bolt 4 PCS (Extra 1)</p>
<p>#6</p> 	<p>#7</p>  <p>2"*Ø1/4"*D11mm</p>	<p>#8</p>  <p>1-1/2"*Ø1/4"*D11mm</p>	<p>#9</p> 	<p>#10</p> 
<p>Barrel Nut 4 PCS</p>	<p>Long Bolt 4 PCS (Extra 1)</p>	<p>Short Bolt 2 PCS (Extra 1)</p>	<p>Shelf Holder 12 PCS</p>	<p>Long Screw 3 PCS</p>
<p>#11</p> 	<p>#12</p> 	<p>#13</p> 		
<p>Adjustable Leveler 8 PCS</p>	<p>Short Screw 21 PCS (Extra 1)</p>	<p>Allen Wrench 1 PC</p>		

ADDITIONAL TOOLS (Not Provided)

Note: It is not recommended to use power tools during assembly.

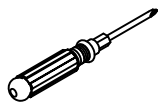

Phillips Head Screwdriver

Note: Wood dowels are intended for alignment. Additional clearance between wood dowel and pre-drilled hole is intentional for ease of assembly.

Please do not use tools to assemble this unit unless specifically indicated.

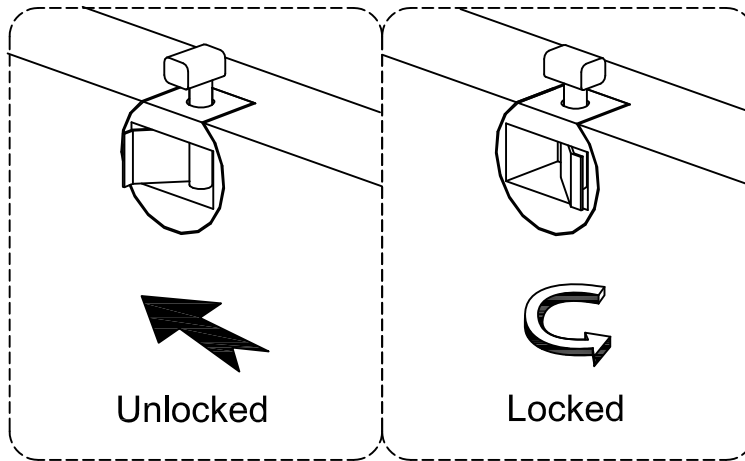

Reference the images above any time the instructions state "lock the hardware".
 Note: Be sure to check all hardware is locked when completed.

Step 1. Attach magnets (part #2) to partition panels (parts D & E) using round head screws (part #3) and phillips head screwdriver. Attach adjustable levelers (part #11) to left panel (part B), right panel (part C) and support legs (part N). Attach top rail (part M) to top panel (part A) using wood dowels (part #1), long screws (part #10) and phillips head screwdriver. Attach handles (part #4) to doors (parts G & H) using round head bolts (part #5) and phillips head screwdriver.

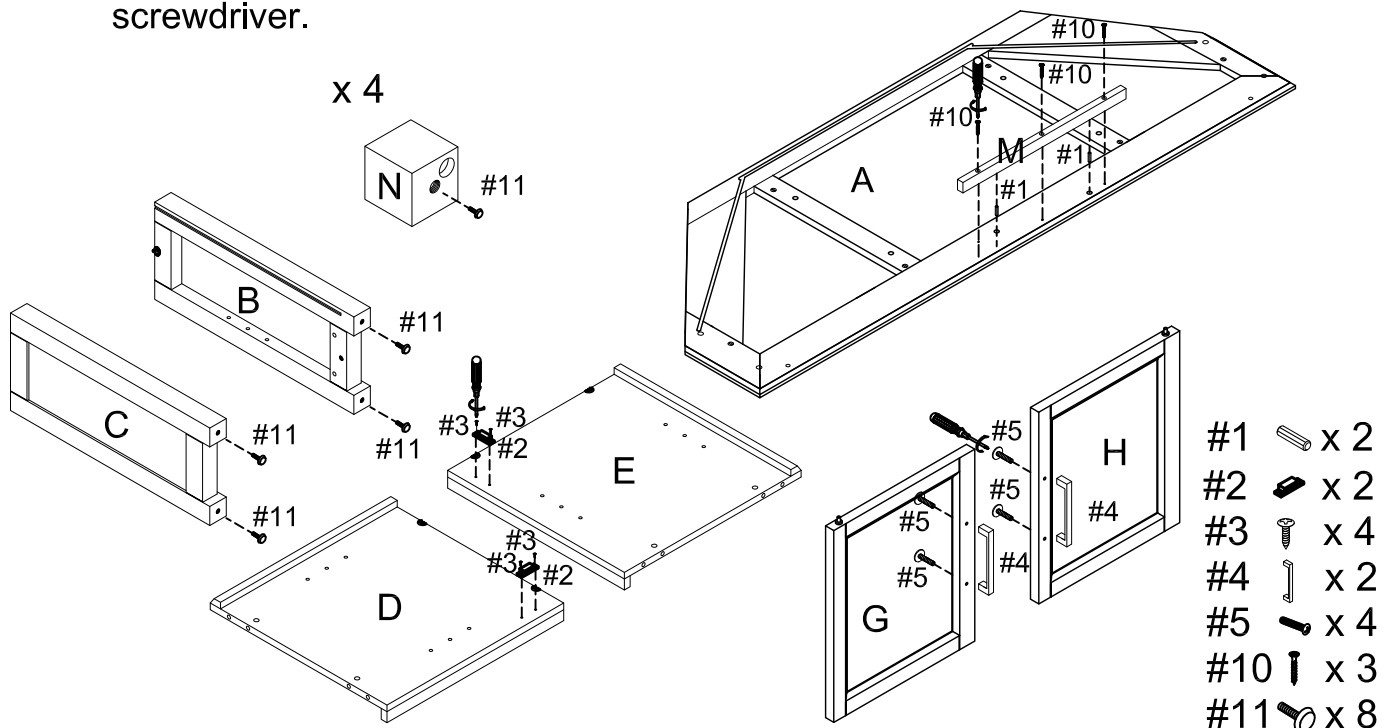

Step 2. Attach partition panels (parts D & E) to bottom panel (part F) using wood dowels (part #1), barrel nuts (part #6), long bolts (part #7) and allen wrench (part #13). Attach left panel (part B) and right panel (part C) to bottom panel (part F) using wood dowels (part #1), short bolts (part #8) and allen wrench (part #13).

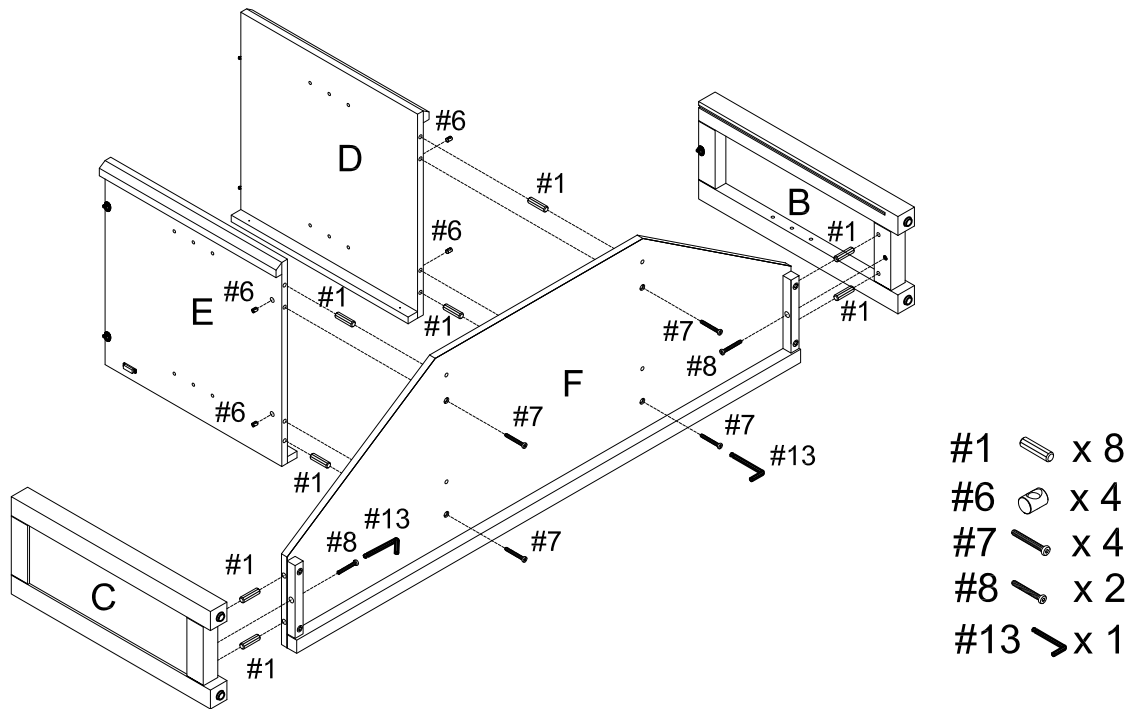

Step 3. Attach support legs (part N) to bottom panel (part F).

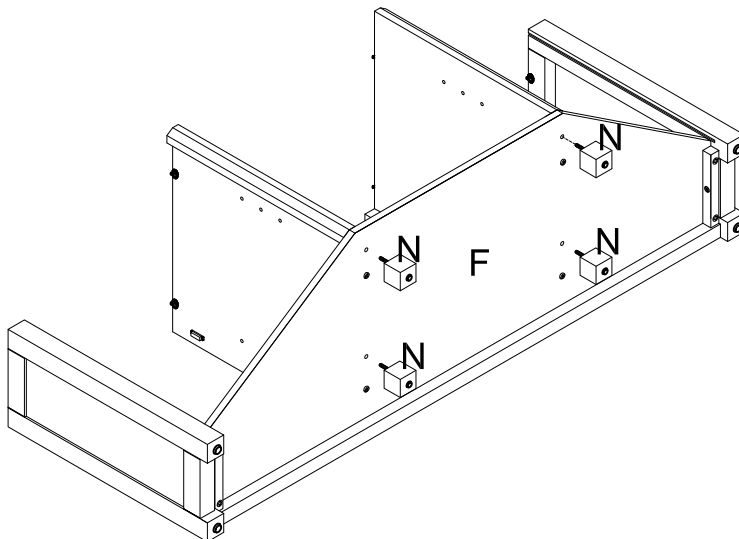

Step 4. Attach top panel (part A) to assembled unit (parts B, C, D & E) using wood dowels (part #1) and lock the hardware.

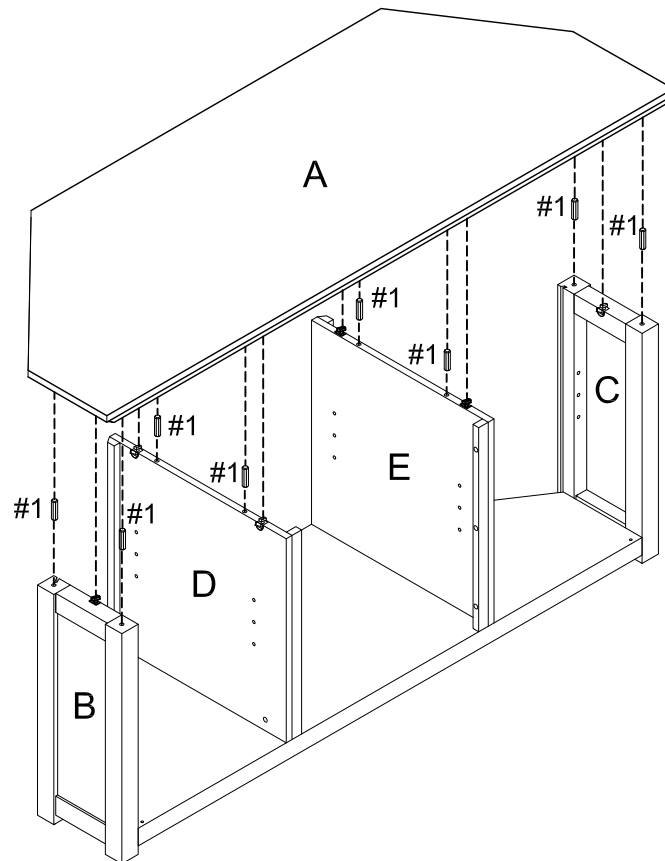

#1  x 8

Step 5. Lay assembled unit upside down. Insert middle back panel (part K) and back panels (part L) into the grooves of top panel (part A), left panel (part B) and right panel (part C).

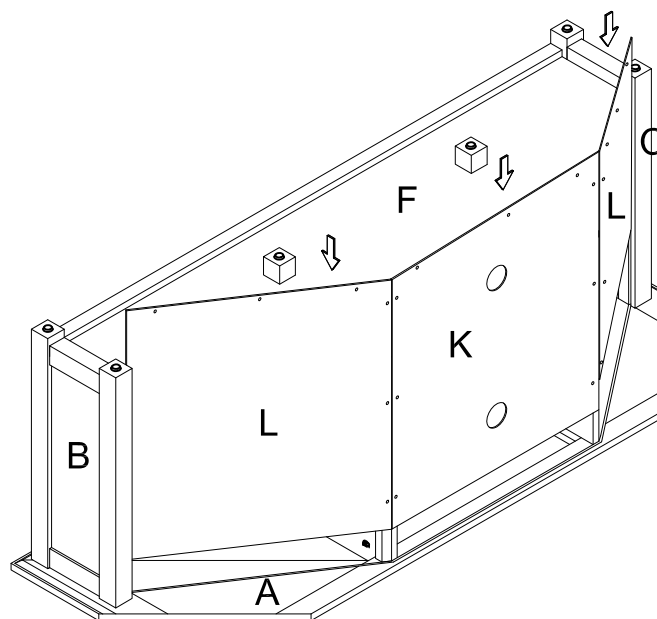

Step 6. Secure back panels (parts K & L) to top panel (part A), left panel (part B), right panel (part C) and bottom panel (part F) using short screws (part #12) and phillips head screwdriver.

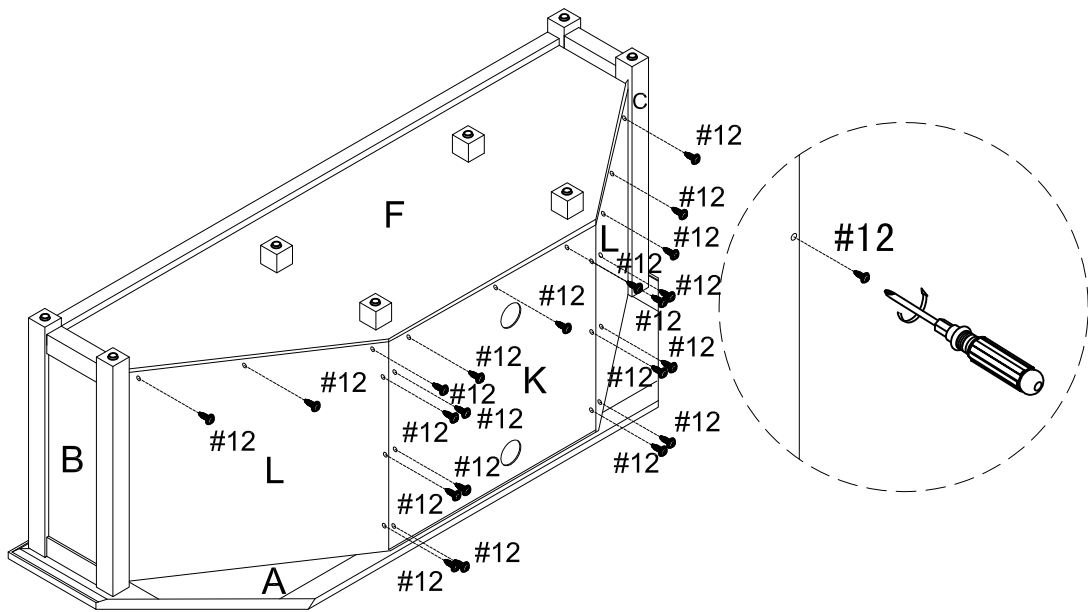

#12  x 21

Step 7. Carefully turn unit upright. Place shelf holders (part #9) into desired position and then slide adjustable shelves (parts I & J) into place.

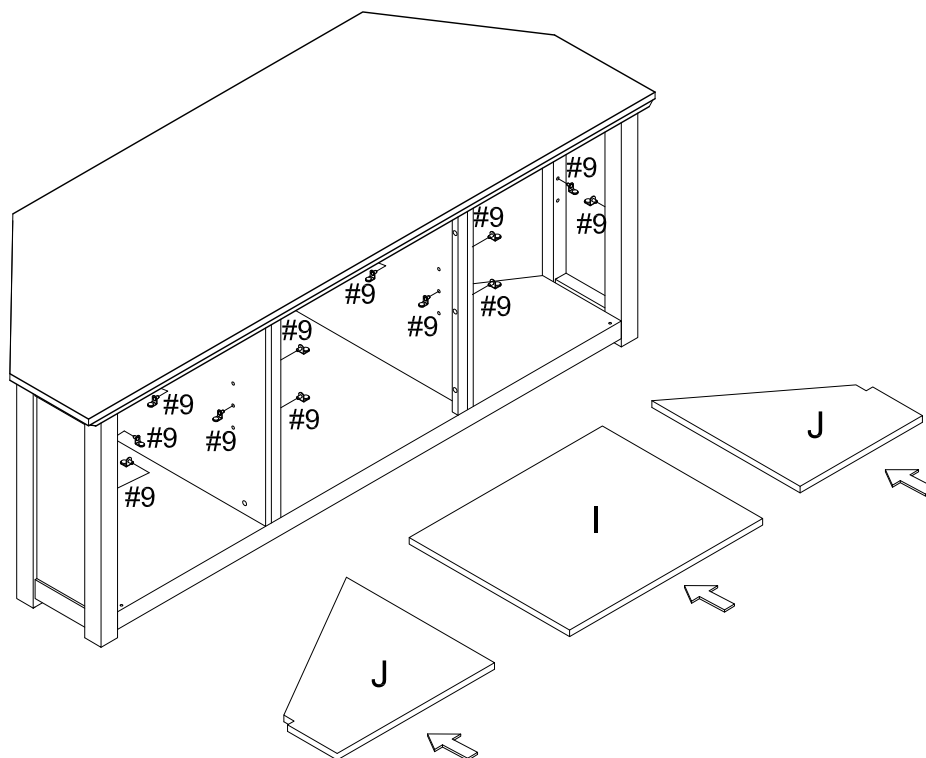

#9  x12

Step 8. Attach doors (parts G & H) by placing bottom pin hinge (pre-installed in door) in the pre-drilled hole of bottom panel (part F). Then depress the top spring-loaded pin hinge so it can be placed in the pre-drilled hole of top panel (part A).

NOTE: Be sure top and bottom pin hinges are fully extended to secure doors in place.

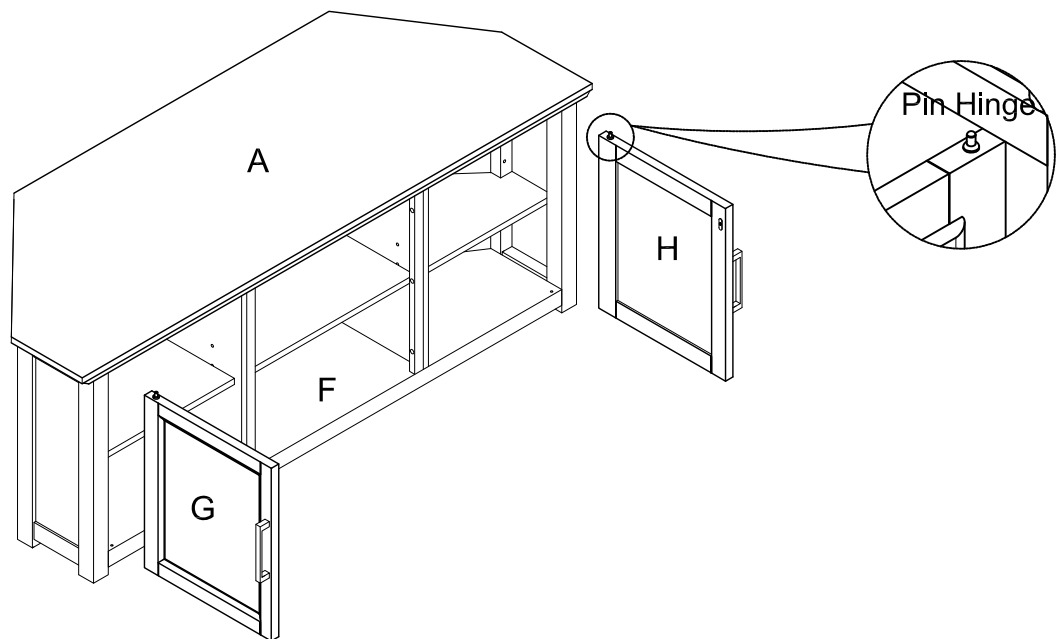

Step 9. If you would like to add an electric fireplace (*Not Included), please follow step 10.

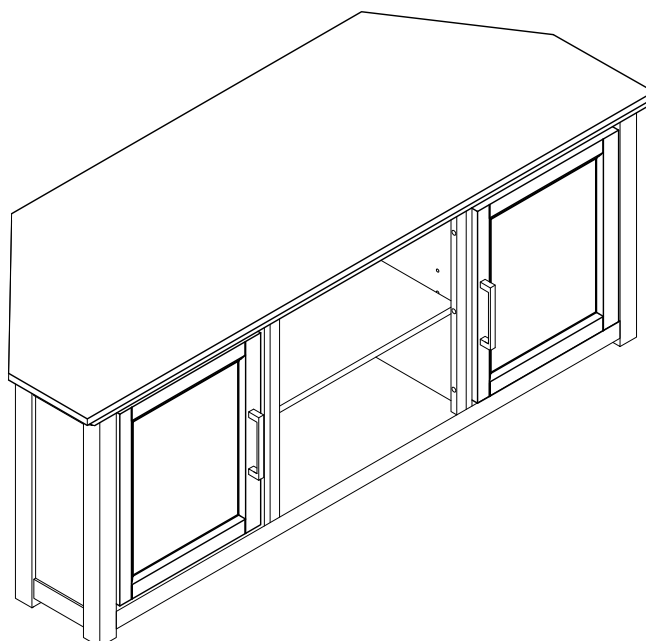

Step 10. Fireplace Assembly: Remove middle adjustable shelf (part I) and middle back panel (part K). Install electric fireplace (*Not Included) into the unit following the assembly instructions of the electric fireplace.

